

WICKETTS -ACO STAINLESS

Stainless Steel Trench
Drain MT-06-SS-80
Type 316L SS

SPECIFICATION

HEAVY DUTY BAR GRATE

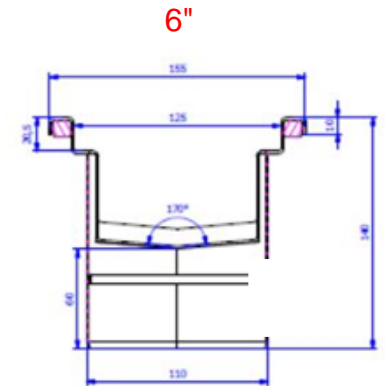
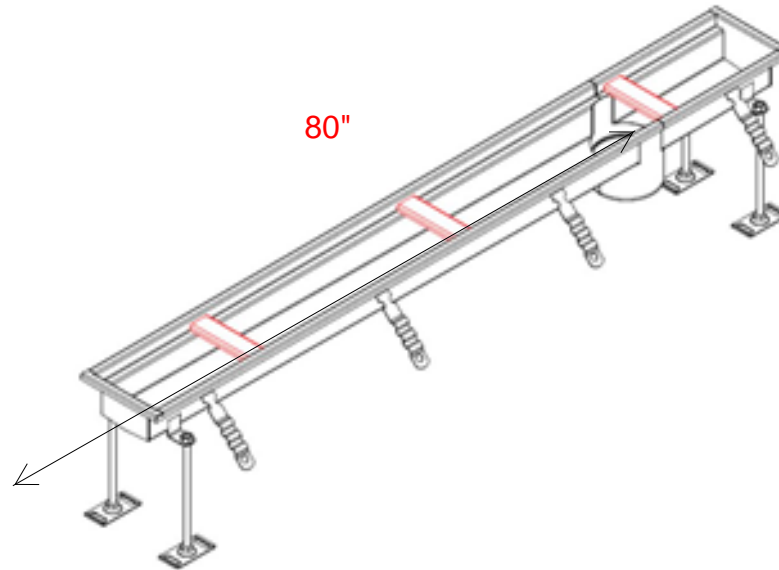

Engineering Specification: 6" Wide 316L Stainless Steel Trench Drain System; Fully Welded End

Caps; And Outlets; Stainless Slotted Grate; 1/8" Per Foot Sloping Channels

WICKETTS STAINLESS TRENCH DRAINS.COM

Conforms to ASME A112.6.3



Wicketts Stainless, INC
825 S. LAKEVIEW AVE UNIT C
PLACENTIA, CA 92870
Tel: 949-438-7535
Fax: 951-638-9059
sales@wickettsstainless.com
www.wickettsstainless.com



Approved for Manufacturing	
Company:	_____
Signature:	_____
Print:	_____