

WICKETTS -ACO STAINLESS

Stainless Steel Trench Drain
MT-06-SS-60
Type 304 SS

SPECIFICATION

HEAVY DUTY BAR GRATE

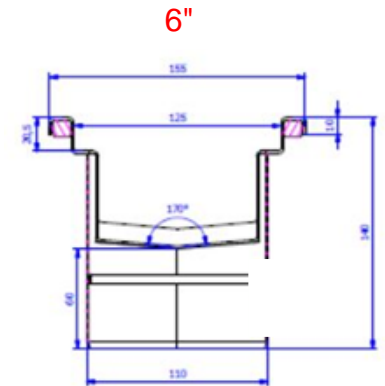
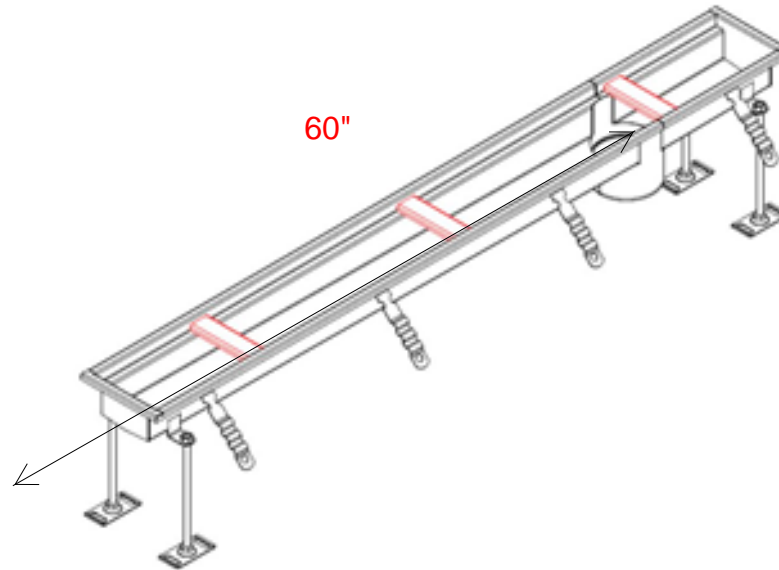

Engineering Specification: 6" Wide 304 Stainless Steel Trench Drain System; Fully Welded End Caps;

And Outlets; Stainless Slotted Grate; 1/8" Per Foot Sloping Channels

WICKETTS STAINLESS TRENCH DRAINS.COM

Conforms to ASME A112.6.3



Wicketts Stainless, INC
825 S. LAKEVIEW AVE UNIT C
PLACENTIA, CA 92870
Tel: 949-438-7535
Fax: 951-638-9059
sales@wickettsstainless.com
www.wickettsstainless.com



Approved for Manufacturing
Company: _____
Signature: _____
Print: _____