

# WICKETTS -ACO STAINLESS

Stainless Steel Trench Drain  
MT-06-SS-100 Type 304 SS

## SPECIFICATION

HEAVY DUTY BAR GRATE

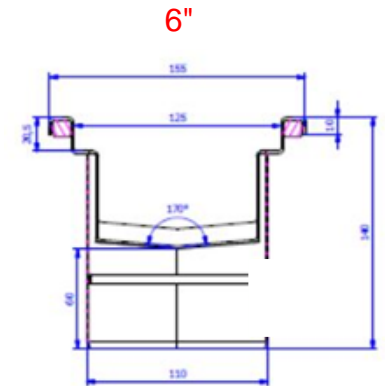
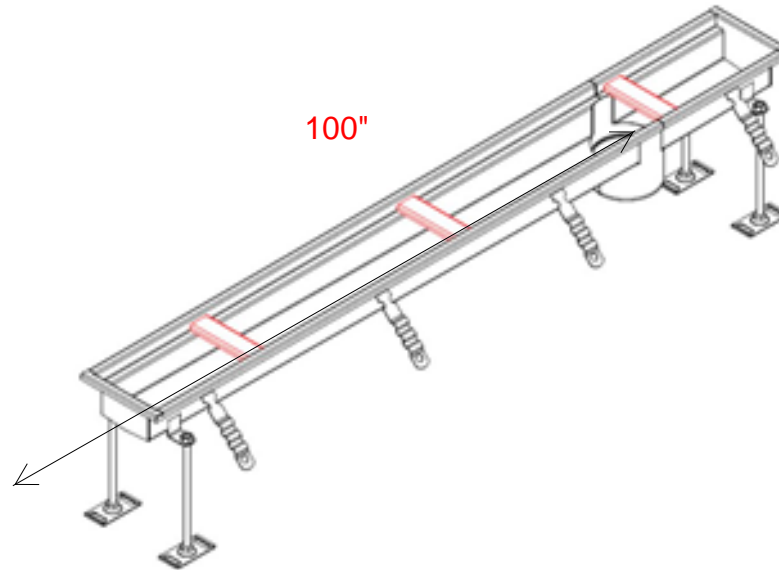

**Engineering Specification:** 6" Wide 304 Stainless Steel Trench Drain System; Fully Welded End

Caps; And Outlets; Stainless Slotted Grate; 1/8" Per Foot Sloping Channels

[WICKETTS STAINLESS TRENCH DRAINS.COM](http://WICKETTS STAINLESS TRENCH DRAINS.COM)

Conforms to ASME A112.6.3



Wicketts Stainless, INC  
825 S. LAKEVIEW AVE UNIT C  
PLACENTIA, CA 92870  
Tel: 949-438-7535  
Fax: 951-638-9059  
sales@wickettsstainless.com  
www.wickettsstainless.com



Approved for Manufacturing
Company: _____
Signature: _____
Print: _____